

# USER MANUAL

## *STOKE*



**evolve**  
SKATEBOARDS  
[WWW.EVOLVESKATEBOARDS.COM](http://WWW.EVOLVESKATEBOARDS.COM)

# **CONGRATULATIONS ON YOUR PURCHASE!**

From all of us at Evolve, we wanted to thank you for choosing us. We are stoked to welcome you to the Evolve community!

Evolve Skateboards are an exciting product and will provide you with endless fun. Please read **ALL** the information within before you begin using your equipment.

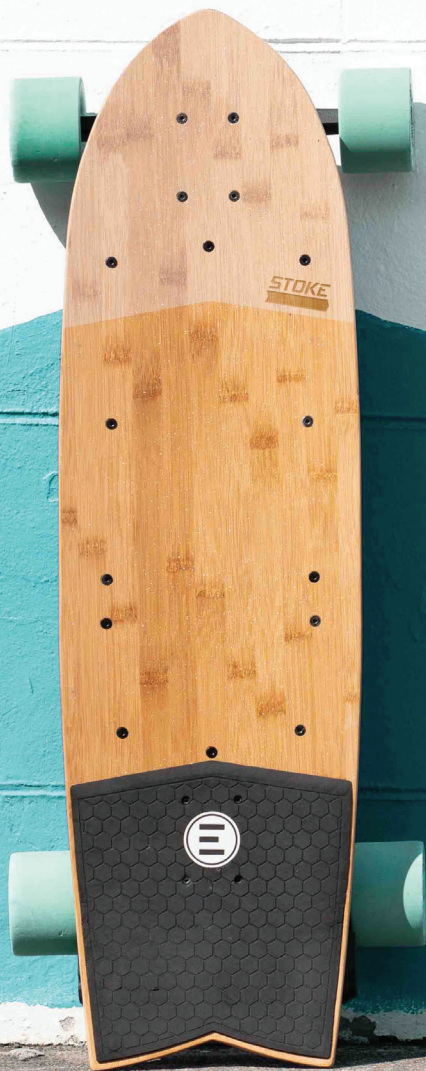

[WWW.EVOLVESKATEBOARDS.COM](http://WWW.EVOLVESKATEBOARDS.COM)

# CONTENTS

<b>STOKE</b>	<b>6</b>
<b>FOOT PLACEMENT</b>	<b>8</b>
<b>REMOTE</b>	<b>9</b>
<b>DO NOT RIDE BEFORE READING</b>	<b>10</b>
<b>WARNING MESSAGES</b>	<b>12</b>
<b>CHARGING THE BOARD</b>	<b>14</b>
<b>CHARGING THE REMOTE</b>	<b>15</b>
<b>TURNING THE BOARD ON / OFF</b>	<b>16</b>
<b>TURNING THE REMOTE ON / OFF</b>	<b>17</b>
<b>REMOTE SCREEN GUIDE</b>	<b>19</b>
<b>REMOTE MENU CONTROLS</b>	<b>20</b>
<b>PAIRING / SYNCING THE REMOTE</b>	<b>21</b>
<b>CHANGING SPEED MODES ON THE REMOTE</b>	<b>22</b>
<b>SAFETY SWITCH</b>	<b>24</b>
<b>HOW TO ACCELERATE</b>	<b>25</b>
<b>HOW TO BRAKE</b>	<b>26</b>
<b>CONTROLLING THE BOARD</b>	<b>27</b>

<b>CHANGING WHEEL AND GEAR SETTINGS</b>	<b>28</b>
<b>SELECT KMH OR MPH</b>	<b>29</b>
<b>BATTERY INDICATOR DISPLAY</b>	<b>30</b>
<b>CHANGE BATTERY INDICATOR DISPLAY</b>	<b>31</b>
<b>LOW BATTERY WARNINGS ON THE REMOTE</b>	<b>32</b>
<b>TRIP METER</b>	<b>33</b>
<b>AUTO SAFE FUNCTION</b>	<b>34</b>
<b>POWER SAVE FUNCTION</b>	<b>35</b>
<b>SPEED LIMITER</b>	<b>36</b>
<b>R2 TRIGGER RESET PROCEDURE</b>	<b>37</b>
<b>OTHER REMOTE OPERATION FUNCTIONS AND TIPS</b>	<b>40</b>
<b>HEAT PROTECTION WARNING</b>	<b>41</b>
<b>ERROR CODES</b>	<b>42</b>
<b>MAINTENANCE GUIDE</b>	<b>43</b>
<b>BATTERY CARE</b>	<b>44</b>
<b>TROUBLE SHOOTING</b>	<b>45</b>

# STOKE

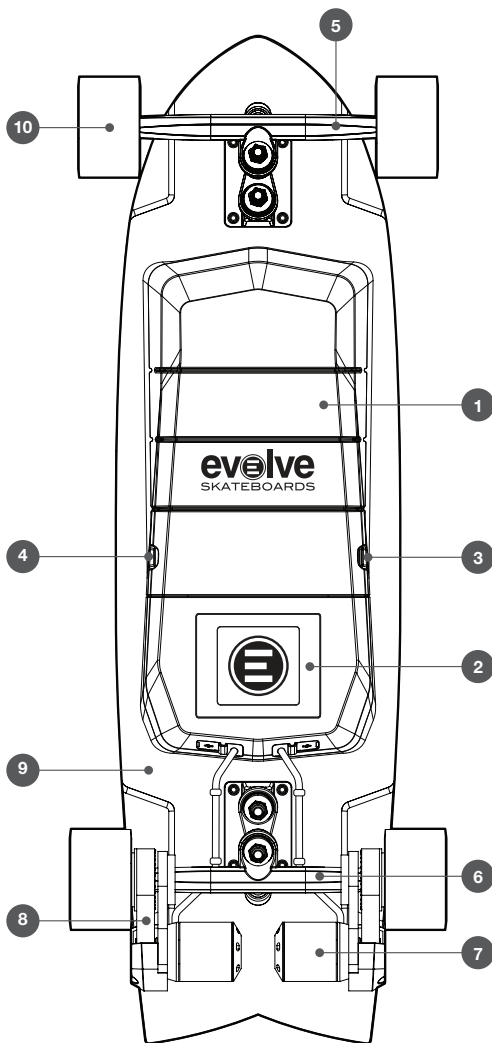

1. Battery
2. Motor Controller
3. Charger port
4. ON/OFF switch
5. Front truck
6. Rear truck
7. Motors
8. Belt
9. Deck
10. Street Wheels

# STOKE

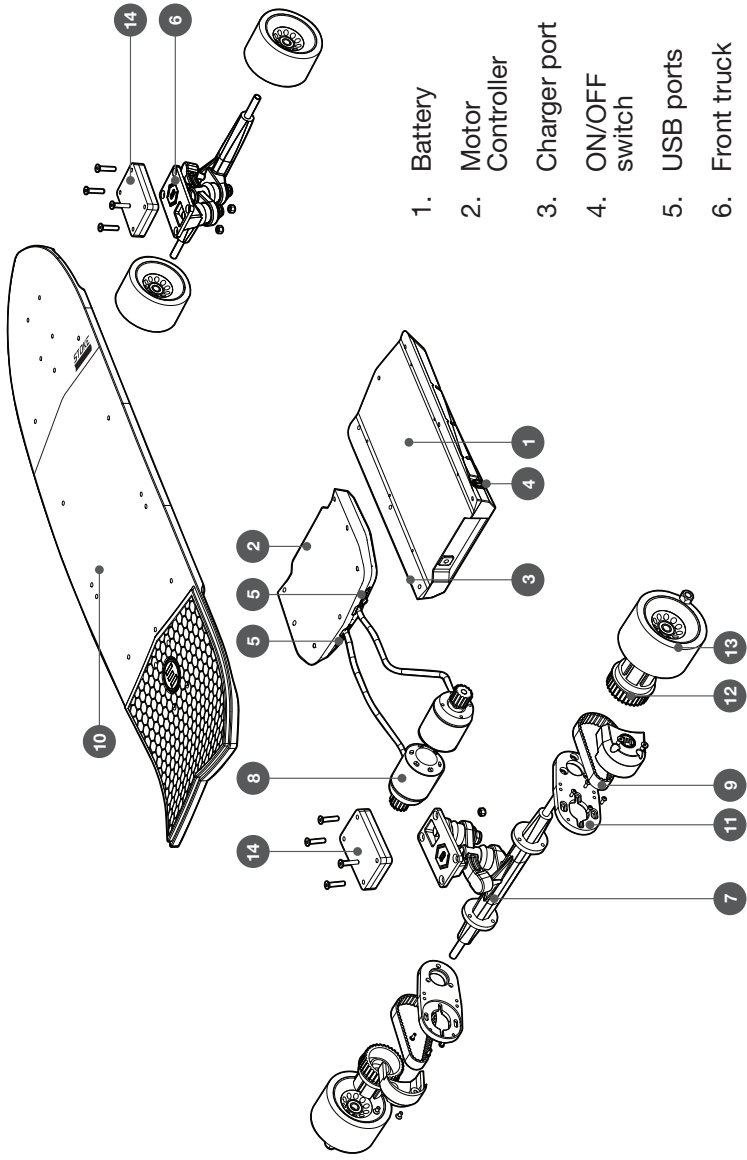

- 1. Battery
- 2. Motor Controller
- 3. Charger port
- 4. ON/OFF switch
- 5. USB ports
- 6. Front truck
- 7. Rear truck
- 8. Motors
- 9. Belt
- 10. Deck
- 11. Motor Plate
- 12. Drive Gear
- 13. Street Wheels
- 14. Riser Pad



## FOOT PLACEMENT

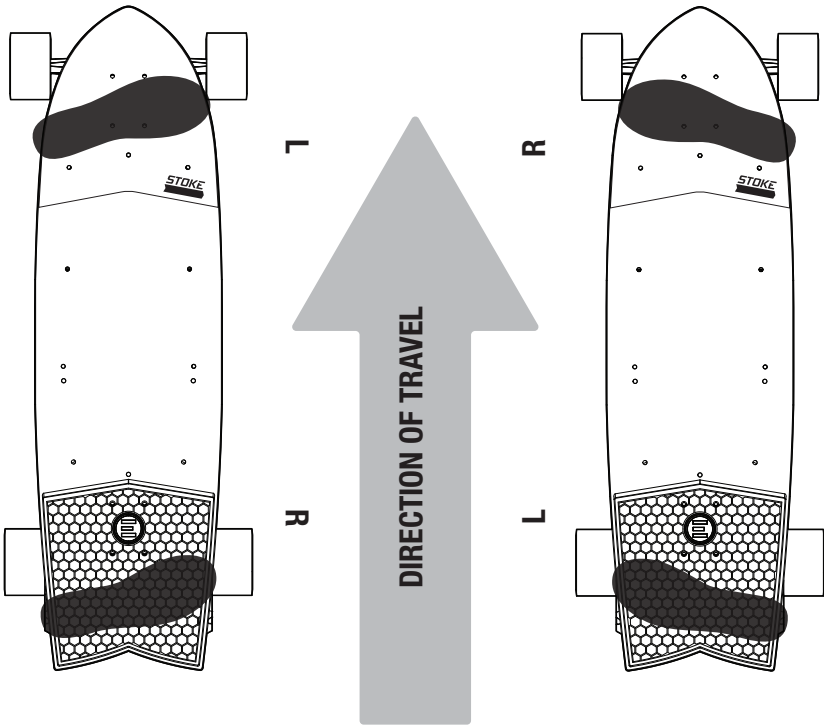

**REGULAR**

**GOOFY**

FOOT PLACEMENT DOES VARY PERSON TO PERSON. THE CLOSER YOUR FRONT FOOT IS TO THE FRONT TRUCK, THE MORE CONTROL YOU WILL HAVE.





# REMOTE

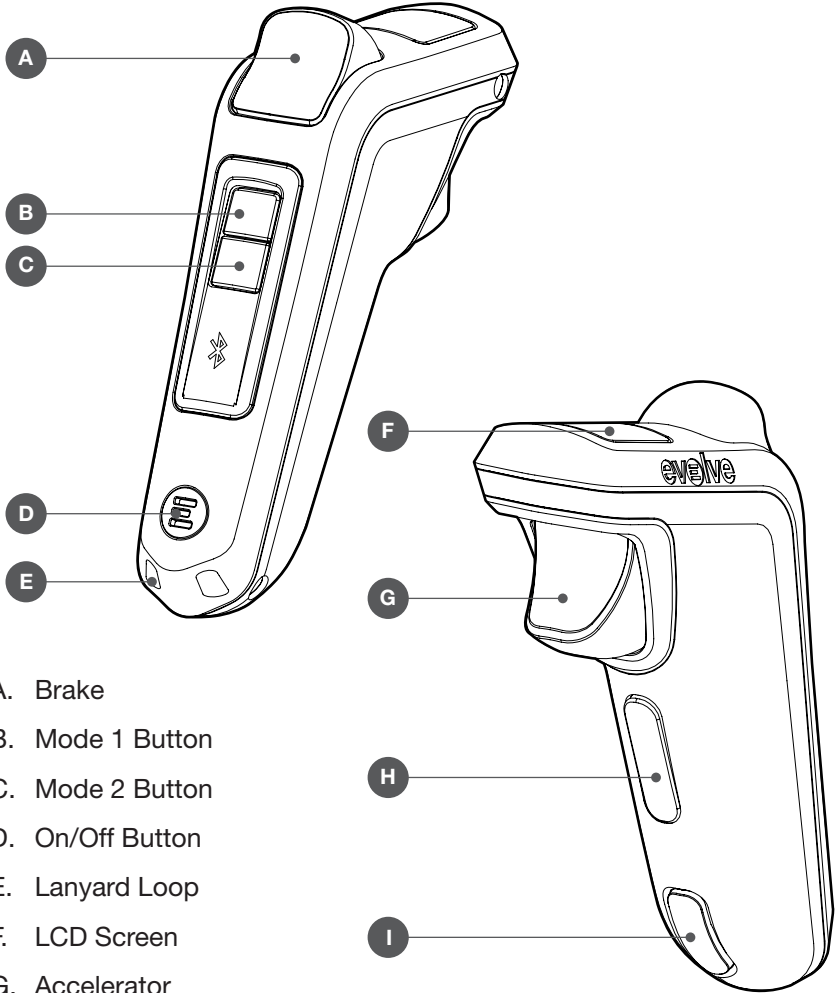

- A. Brake
- B. Mode 1 Button
- C. Mode 2 Button
- D. On/Off Button
- E. Lanyard Loop
- F. LCD Screen
- G. Accelerator
- H. Safety Switch
- I. Charge Port



## DO NOT RIDE BEFORE READING



**ALWAYS** wear a helmet and relevant safety equipment when riding the board.



**ALWAYS** ride your board at speeds at which you are comfortable without power or brakes. Due to a low battery on your board or remote your board can lose brakes and power during your ride.



**ALWAYS** obey and check the local road rules in your area for where you can ride. Do not ride on busy roads with line markings.



**ALWAYS** respect pedestrians!!!



**PRO** and **GTR** modes are very powerful and the remote acceleration and brakes are highly sensitive. Be sure to be very gentle with these controls to avoid being thrown off the board.

Start by trying to move as slowly as possible within these speed modes while using both the brake and accelerator.



**DO NOT RIDE** the board if you are under the influence of drugs or alcohol.



**DO NOT RIDE** the board in wet conditions. The board may slide from under your feet causing injury.



## WARNING MESSAGES



### INJURIES

Whenever you ride an Evolve board, you risk serious injury or even death from loss of control, collisions or falls. To ride safely, you must read **ALL** instructions, safety messages and warnings in this manual.



### AVOID WATER

The board is not waterproof. The electronics, bearings and other components may be damaged due to water. Riding in wet conditions is very dangerous and may cause injury.

***WATER DAMAGE IS NOT COVERED BY WARRANTY.***



### ABUSE

Do not jump on the board, do not ride off gutters or curbs, do not smash the board into hard objects, do not drop the board on the ground for starting operation. Although the product has been made to handle rigorous riding, it is still an electrical product and needs to be handled with care and respect.

***ABUSE TO THE BOARD AS LISTED ABOVE IS NOT COVERED BY WARRANTY.***



## **RIDING ON HILLS**

Riding on hills can be extremely dangerous; what goes up must come down! So if you ride up an insanely steep hill and you intend to ride down this same hill, you must know how to control your speed without the use of the electric brakes. This is because there could be a malfunction with the brakes.

Although the **GTR** boards can climb hills of up to 25-degree gradient, riding continuously on an insanely steep hill will put massive stress on the electronics.

We have installed current protections within our electronics, however if you feel the board slowing down on a steep hill this is because the protection is kicking in and giving you warning it's working too hard. At this time, you must consider stopping to avoid risking damage to the electronics.

***DAMAGE TO ELECTRONICS THROUGH STRAIN ON MOTORS IS NOT COVERED BY WARRANTY.***



## CHARGING THE BOARD

**BEFORE USING** the board, allow the battery to be **FULLY CHARGED**.

Connect power to the charger by inserting the charger plug into a power point. Now remove the rubber grommet from the charger port on the board and insert the charger plug.

The charger will show:

- **GREEN LIGHT = FULLY CHARGED**
- **RED LIGHT = CHARGING**

Once the board is fully charged (the light on the charger will turn green) remove the charge plug from the board, re-install the rubber grommet on the board and remove the plug from the power point.

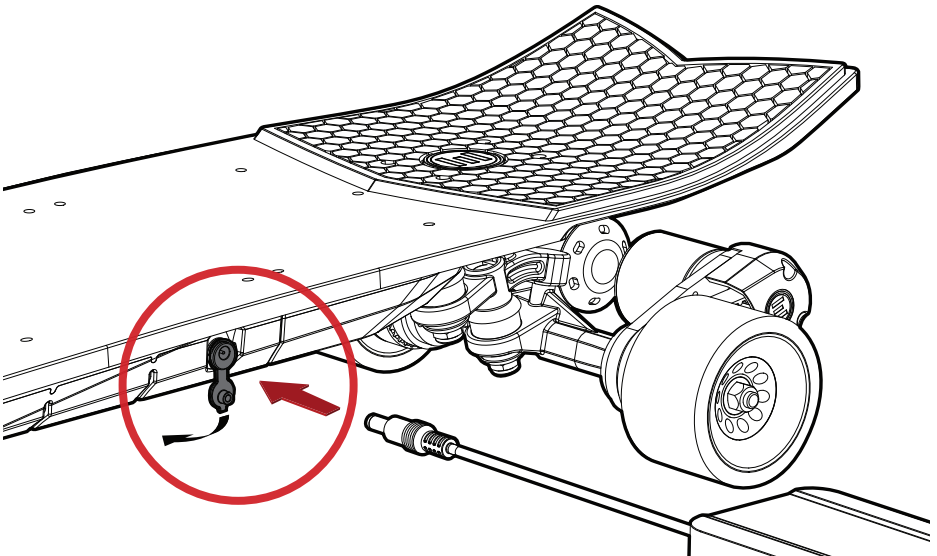



## CHARGING THE REMOTE

To charge the remote, simply dislodge the rubber grommet covering the charge port and insert the Micro-USB plug of the charge cable carefully into the charge port of the remote, and the USB plug end into a suitable USB port.

The remote will show:

- **GREEN LIGHT = FULLY CHARGED**
- **RED LIGHT = CHARGING**

Once the remote is fully charged remove the Micro-USB plug from the remote and re-install the rubber grommet on the remote.

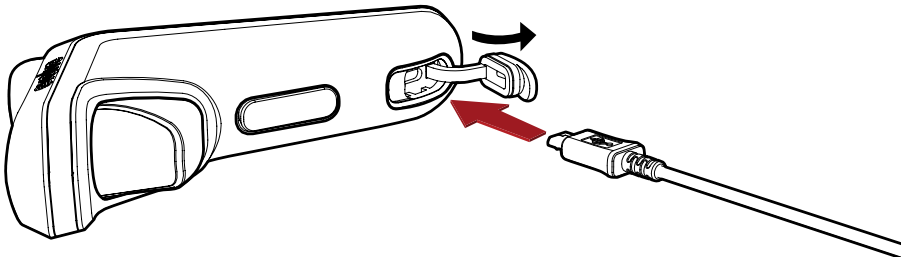

**NOTE - THE REMOTE MAY NOT COME FULLY CHARGED.**



## TURNING THE BOARD ON / OFF

To turn the board on, press the **ON/OFF BUTTON** in. It will illuminate to a solid blue light indicating the board is on.

To turn the board off, simply press the **ON/OFF BUTTON** in again and the light will turn off as the button returns to the off position.

**THE BOARD WILL TIME OUT AFTER 5 MINUTES OF NON-USE, IN WHICH CASE ALTHOUGH THE SWITCH IS STILL IN, THE LIGHT WILL TURN OFF. TO REACTIVATE THE BOARD, IT WILL HAVE TO BE TURNED OFF, AND BACK ON AGAIN.**

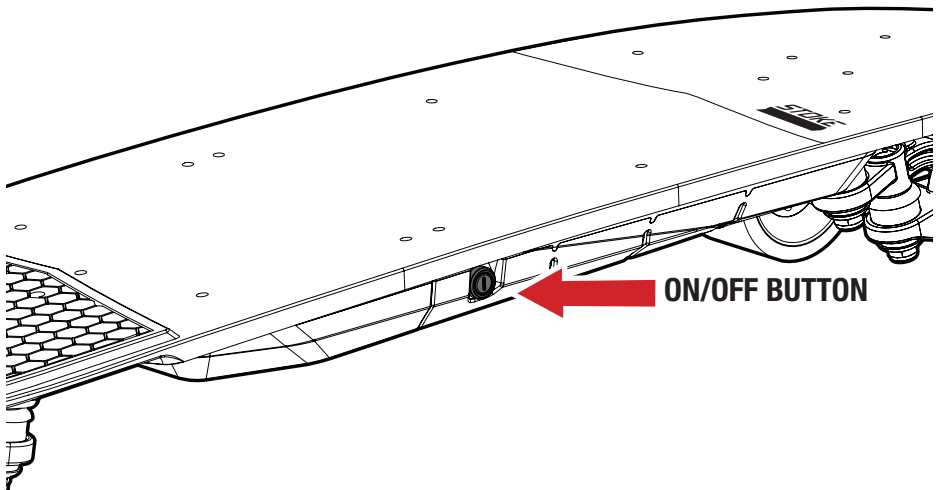





## TURNING THE REMOTE ON / OFF

To turn the remote ON, quickly press the **ON/OFF BUTTON** one time, the remote will vibrate once and the LCD screen will power on, displaying the Evolve logo. The **ON/OFF BUTTON** will light up on the remote and display the default screen.

To turn the remote off, press and hold the **ON/OFF BUTTON** for one second or until the screen and **ON/OFF** light turn off.

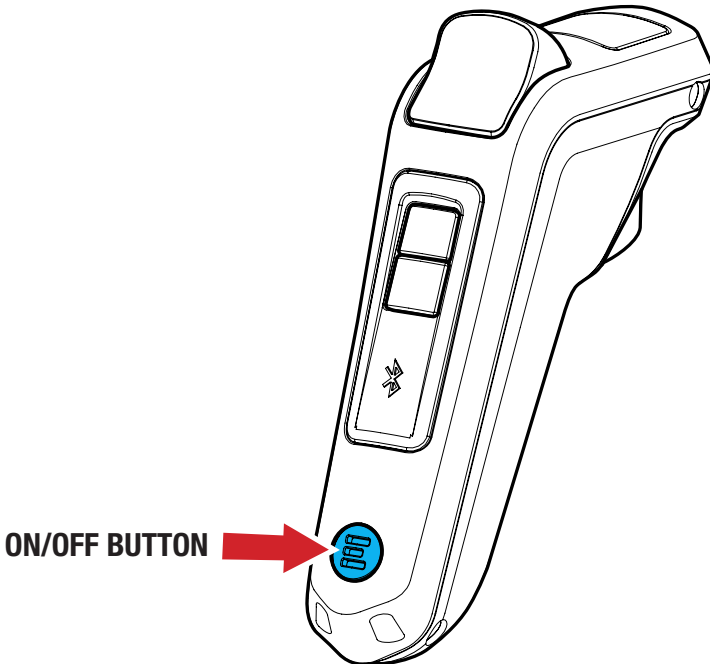

FOR BEST CONNECTION, TURN THE BOARD ON 1<sup>ST</sup> AND THE REMOTE 2<sup>ND</sup>.





## REMOTE SCREEN GUIDE

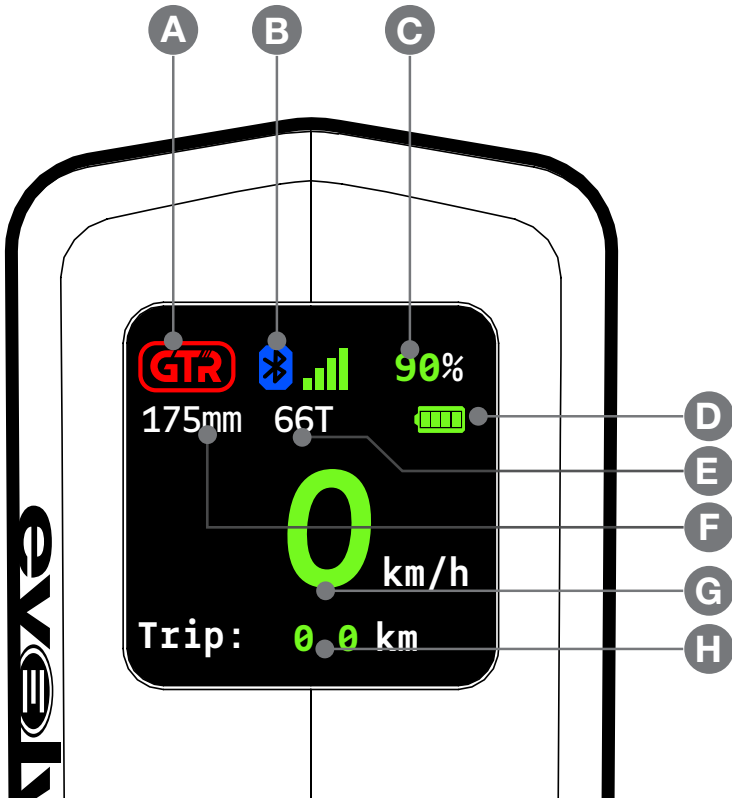

- |                         |                  |
|-------------------------|------------------|
| A. Speed mode           | E. Gear Setting  |
| B. Bluetooth Connection | F. Wheel Setting |
| C. Board Battery        | G. Speedometer   |
| D. Remote Battery       | H. Trip Meter    |

NOTE – DEFAULT SCREEN SHOWN

## **REMOTE MENU CONTROLS**

To access the menu, turn the remote on, then double tap the **ON/OFF BUTTON**.

When in the menu use **MODE 1** and **MODE 2** to navigate/scroll through menu lists.

Use the **ON/OFF BUTTON** to confirm selections.





## PAIRING / SYNCING THE REMOTE

1. Turn the skateboard on.
2. Turn the remote on.
3. Press and hold the **MODE 1 BUTTON** on the remote for one second or until the Bluetooth symbol begins to flash.
4. Once paired, the Bluetooth symbol will switch to a solid symbol and the battery display will show a reading. This means you are ready to ride!

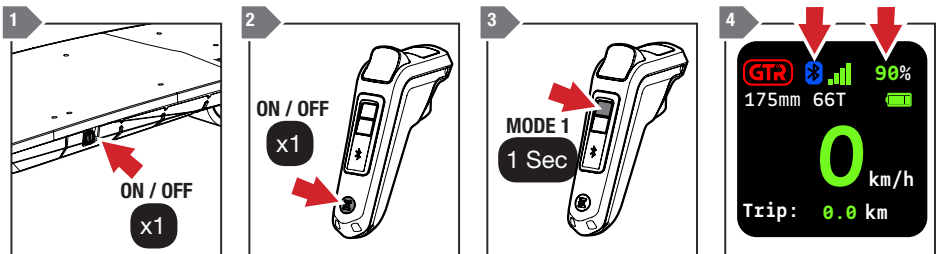

**NOTE – ONCE THE REMOTE AND BOARD ARE SYNCED TOGETHER, THE NEXT TIME YOU USE YOUR BOARD IT WILL AUTOMATICALLY SYNC. THERE ARE ALSO BARS NEXT TO THE BLUETOOTH SYMBOL TO INDICATE SIGNAL STRENGTH.**

**TIP – Make sure not to touch the acceleration or brake triggers as the remote is pairing to the board. Once paired, lift the wheels off the ground and accelerate. Then brake to test that the control is clean and smooth. If there are any delays in the control, turn both the board and remote off and retry the above process.**



## CHANGING SPEED MODES ON THE REMOTE

Once your remote is on and paired to your skateboard it will begin in '**SAFE MODE**' as the first speed mode setting.

Now press either **MODE 1** or **MODE 2** button once, this will change the speed from **SAFE MODE** to the previous speed setting of your last ride.

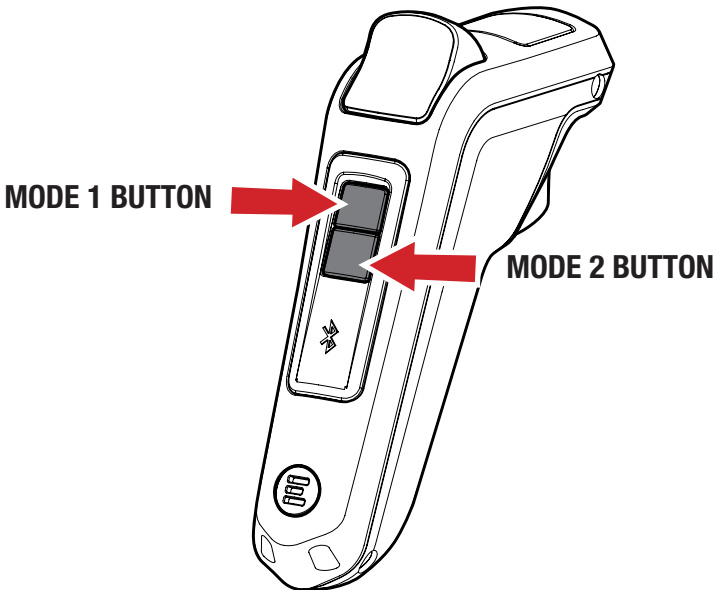

Each time you press the **MODE 1 BUTTON**, this will **INCREASE** the speed mode from **ECO MODE** through to **CUST MODE**.

Each time the **MODE 2 BUTTON** is pressed it will **DECREASE** the speed mode from **CUST MODE** through to **ECO MODE**.

Each time you press the **MODE 1** or **MODE 2** button to change your speed settings the remote will vibrate one time giving warning the speed mode has changed.

The speed mode is clearly displayed in the top left corner of your LCD screen.

**ECO**

#### **ECO SPEED MODE**

Economical cruising mode with 75% of top speed. Best for beginners and longest ride times.

**PRO**

#### **PRO SPEED MODE**

Fast acceleration, can reach top speed, good for smaller hills and short grass.

**GTR**

#### **GTR SPEED MODE**

Insane acceleration, reaches top speed quickly, will tackle any hill, dirt tracks and grassy terrain.

**CUST**

#### **CUSTOM SPEED MODE**

Custom mode allows you to set the power curve that's just right for your riding style. The power curve can be adjusted via the **EXPLORE BY EVOLVE APP** which is available on the ITUNES App Store or on the Android Play Store.

**TIP** - Use the speed change buttons as you would gears on a bike. Cycle through them according to the riding situation, for example: Select **PRO** or **GTR MODE** for an approaching hill, then cycle back down to **PRO** or **ECO MODE** once you have reached the top of the hill. **CUSTOM MODE** is your individual power curve preference, whether its weak acceleration or insane acceleration, this is your go to mode that best suits your riding experience.



## SAFETY SWITCH

The **SAFETY SWITCH** is located under the accelerator trigger. It must be pressed by your 2<sup>nd</sup> and/or 3<sup>rd</sup> finger as you engage the accelerator trigger to begin riding. The speed mode display on the LCD screen will turn a solid color once you press in the **SAFETY SWITCH**.

**IF YOU DO NOT PRESS THE SAFETY SWITCH IN AS YOU ENGAGE THE ACCELERATOR TRIGGER, THE BOARD WILL NOT MOVE.**

Once you begin moving and reach speeds of 3-5km/hr or above, you will be able to ride freely without engaging the **SAFETY SWITCH** during acceleration, braking or neutral trigger movements. When you come to a stop or reach 0km/hr, the **SAFETY SWITCH** reactivates. You must press in the **SAFETY SWITCH** the next time you wish to use the accelerator trigger again.

The **SAFETY SWITCH** can be disabled or re-enabled by going to the 'Options' menu and changing 'Dead Man' to 'off' or 'on'.



## »» HOW TO ACCELERATE

With the safety switch depressed, pull the **ACCELERATOR** trigger *slowly* and you will begin to move forward. The further you pull the trigger in, the faster you will go.

Once over 5km/h you can release the safety switch. For more information refer to the **SAFETY SWITCH** section.

**TIP** - *Have your weight positioned on the front foot when you accelerate, this stops the board flying out from under your feet!*

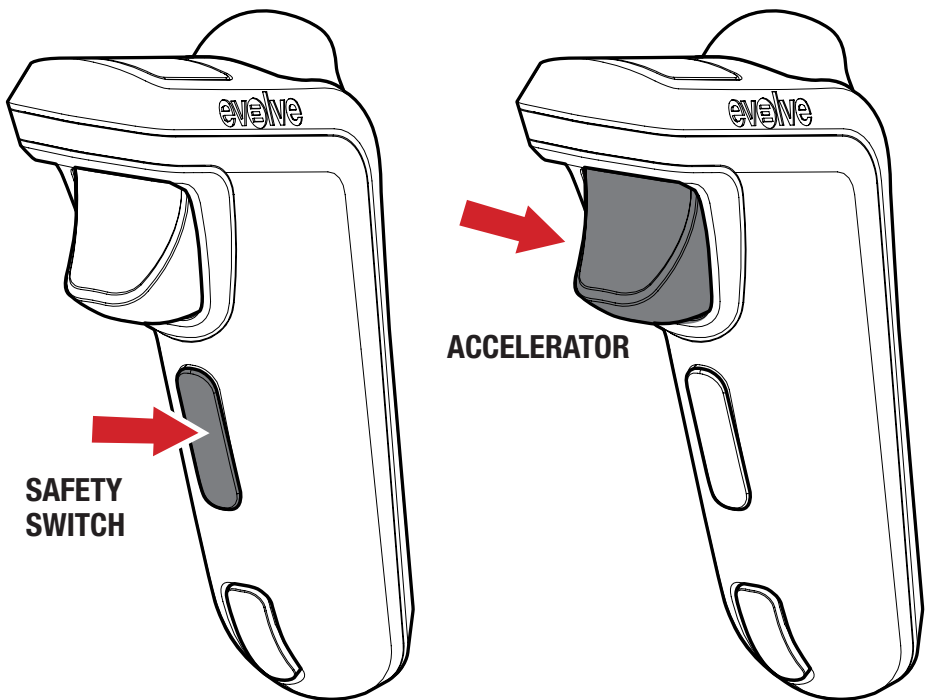

## ◀◀ HOW TO BRAKE

Push the brake trigger forward **SLOWLY** and you will begin to slow down. The further you push the trigger, the stronger the braking will be.

When riding very slowly the brakes will be softer than when you are riding at a higher speed. Have your weight on the back foot when you apply the brake function to stop you from flying forward when applying the brakes.

**TIP** – *The brake trigger takes precedence over all other remote functions and if pressed will cut acceleration, prevent acceleration or changing modes and will not allow you to turn off the remote.*

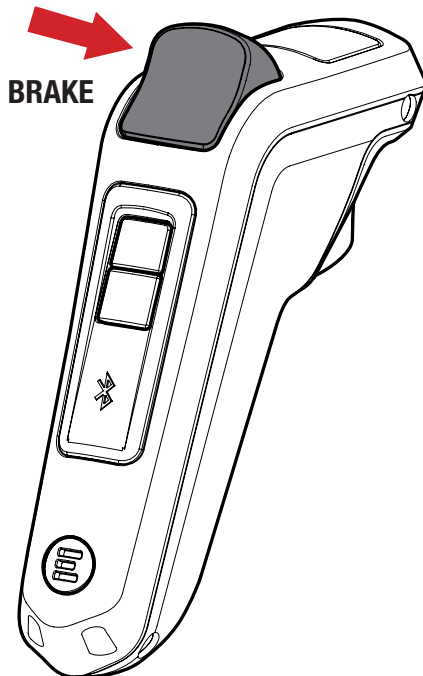



## CONTROLLING THE BOARD

The board is controlled by a combination of the rider and remote. The rider operates the remote which controls accelerating and braking.

Turning and stability is dependent on the rider.

To turn the board the rider must lean in the direction they wish to turn. To keep stable, it is recommended to stay relaxed, so that your body can absorb bumps and movements created by the terrain or remote input.

It is recommended to move your weight toward your front foot whilst accelerating and towards your rear foot whilst braking to account for the forces created by such actions.

Evolve Skateboards highly recommend starting in **ECO MODE** when learning to ride the board and use the remote. Be sure to be very gentle with the trigger control to avoid being thrown off the board. Start by trying to move as slowly as possible within these speed modes when using both the brakes and acceleration.

Slowly progress through the speed modes when comfortable.

**PRO AND GTR MODES ARE VERY POWERFUL AND THE TRIGGER IS HIGHLY SENSITIVE.**



## CHANGING WHEEL AND GEAR SETTINGS

Be sure to select the right wheel and gear combination you are riding with, as this will give you an accurate speed and trip distance display on your remote. The wheel and gear settings are displayed in the top left corner of the LCD screen.

1. From the default screen, double-tap the **ON/OFF BUTTON**. This will now display the menu screen.
2. Wheel Setting will be the first option, press the **ON/OFF BUTTON** to select it. The LCD screen will display All Terrain wheel and gear sizes and Street wheel and gear sizes.

Confirm if you are using either All Terrain wheels or Street wheels, then move the highlighted box to your selection by pressing either **MODE 1** or **MODE 2 BUTTON** then press the **ON/OFF BUTTON**.

3. Use the **MODE BUTTONS** to scroll through to the correct wheel and gear size. Press the **ON/OFF BUTTON** to select correct wheel and gear option. Once selected you will now be back in the default screen.

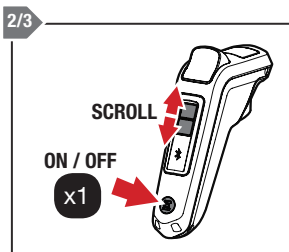
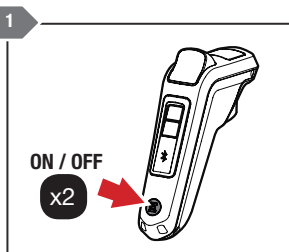

**NOTE – THE STREET BOARDS ALL COME WITH 32T GEAR AS STANDARD. THE AT BOARDS COME WITH 66T GEAR AS STANDARD. OTHER GEAR SIZES AND WHEELS ARE AVAILABLE ON EVOLVE WEBSITES.**



## SELECT KMH OR MPH

1. From the default screen, double-tap the **ON/OFF BUTTON**. This will now display the menu screen.
2. Scroll down by pressing the **MODE 2 BUTTON** until you reach 'Options', then press the **ON/OFF BUTTON**.
3. Press the **ON/OFF BUTTON** to change the unit of measurement for your region (KMH or MPH).
4. Once selected, press the **MODE 2** button to move the highlighted box to the 'Return' selection, then press the **ON/OFF BUTTON**. This will now take you back to the default screen with the preferred unit of measurement.

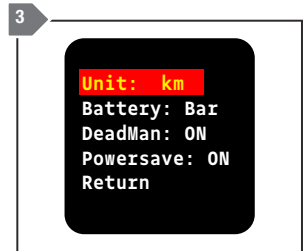
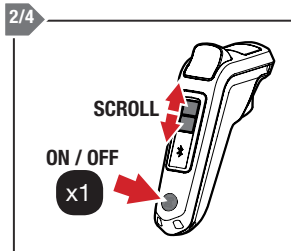
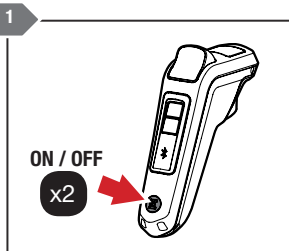



## BATTERY INDICATOR DISPLAY

When the remote is connected to the board, it will display how much battery is left in the skateboard and remote in real time.

The battery of the skateboard is displayed as a small percentage symbol (%) in the top right-hand corner of the LCD screen, and as a small battery bar under the percentage symbol for the remote battery.

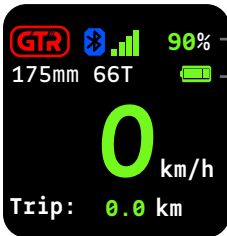

SKATEBOARD BATTERY %

REMOTE BATTERY %



## CHANGE BATTERY INDICATOR DISPLAY

You have the option to change the skateboard battery percentage display to a skateboard battery bar if you prefer.

1. Double-tap the **ON/OFF BUTTON**. This will now display the menu screen.
2. Scroll down by pressing the **MODE 2 BUTTON** until you reach 'Options', then press the **ON/OFF BUTTON**.
3. Use the **MODE BUTTONS** to scroll through to the 'Battery' selection then press the **ON/OFF BUTTON** to change from 'Dig' (percentage) to 'Bar' or vice versa.
4. Scroll down by pressing the **MODE 2 BUTTON** until you reach 'Return', then press the **ON/OFF BUTTON**. This will take you back to the default screen with the new battery display.

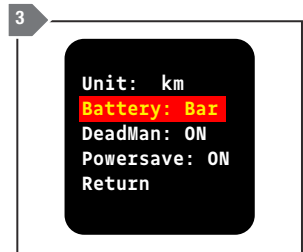
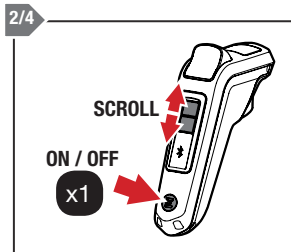
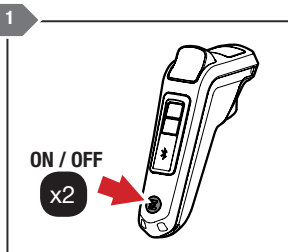

**TIP** - As you ride your skateboard and use your remote, the skateboard battery meter and remote battery meter will slowly deplete. If you ride up hills, accelerate heavily, and ride over grass you should expect the battery to drain faster than if you were riding on flat, smooth surfaces. To get the longest ride times, ride holding a set speed, avoiding start/stop riding. This is the most efficient way to ride.



## LOW BATTERY WARNINGS ON THE REMOTE

There are low battery warnings set on the remote that provide you with notice of when to expect the skateboard to run out of power. See below at what stage the warnings come on:

1. At **10%** the remote will vibrate quickly one time.
2. At **5%** the remote will vibrate once every 5 seconds.
3. At **1%** the remote will vibrate for 5 seconds with a brief pause then continue to vibrate.
4. At **0%** the remote will continue to vibrate then go into **ECO MODE**. During this time you will not be able to use **PRO** or **GTR** speed modes as the battery is virtually flat.

**NOTE – THE AUTO ECO MODE WILL PREVENT THE BOARD FROM TURNING OFF SUDDENLY WHEN THE BATTERY IS VERY LOW ON VOLTAGE AND THE RIDER IS TRYING TO STILL RIDE THE BOARD IN THE FASTER CURRENT SPEED MODES. THIS PROTECTS BOTH THE RIDER AND BATTERY.**

**IF THE RIDER CHOOSES TO IGNORE THE LOW BATTERY WARNINGS, THE BATTERY METER SOFTWARE WILL ALLOW THE RIDER TO CONTINUE TO USE THE BOARD FOR A SHORT TIME AFTER THE BATTERY METER GOES TO 0%.**





## TRIP METER

The trip display will show your distance travelled for your current ride only.

Once you turn your board off the trip meter will reset itself and return to 0 value.

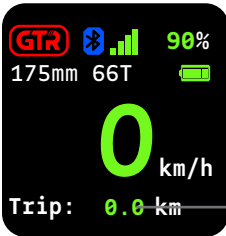

TRIP METER

**NOTE - FOR BEST ACCURACY, BE SURE TO HAVE SELECTED THE CORRECT WHEEL AND GEAR SETTING SIZE ON YOUR REMOTE. IF THE INCORRECT SELECTION IS BEING USED ON THE REMOTE, THE REMOTE WILL GIVE THE INCORRECT SPEED AND TRIP DISTANCES.**

**REFER TO CHANGING WHEEL AND GEAR SETTINGS FOR MORE INFORMATION.**



## AUTO SAFE FUNCTION

The auto safe function is a feature of the remote that is designed to detect any potential issues with the control of the board.

This can relate to anything to do with the battery performance, motor controller performance and remote operational control.

The auto 'Safe' mode will be activated if any of the above is disturbed, even if it's minor, the remote will detect and make the control go to safe mode.

If the safe mode does come on when riding, the remote will vibrate for one second giving you warning and the control feeling will have weak acceleration and braking strength. If there is a genuine error with the skateboard, error messages will be displayed in the 'Product Info' screen.

To get out of the auto 'Safe' mode function, simply press the **MODE 1** button to then be taken back to the previous speed setting you were riding.



## **POWER SAVE FUNCTION**

To maximize the battery run time in the remote, there is a power save function that makes the remote screen turn off when the remote is at a low angle.

Power save will automatically activate one minute after the remote is turned on.

When the rider lifts the remote to a more level position, it will turn back on.

To deactivate/reactivate this function, go into the 'Options' section of the remote menu and change the settings for 'Power Save'.

# SPEED LIMITER

The speed limiter has been designed to cap top speeds for certain country laws as well as for those riders who are happy only to ride at a certain speed. The power and torque is still exactly the same when the limiter is activated, however the top speed is limited. To access the speed limiter, follow these steps:

1. Double click the **ON/OFF BUTTON** on your remote. This will bring you into the main menu screen.
2. Scroll down by pressing the **MODE 2 BUTTON** until you reach 'Speed limit', then press the **ON/OFF BUTTON**.
3. Scroll to the desired speed limit - 32km/hr, 25km/hr, 20km/hr or OFF, then press the **ON/OFF BUTTON** to select. A green tick will then be placed next to the selected speed setting.

*Please note, the speed limit selection will also be displayed on the home screen as a yellow colour on the KM/HR display and a white colour when the speed limiter is turned off.*

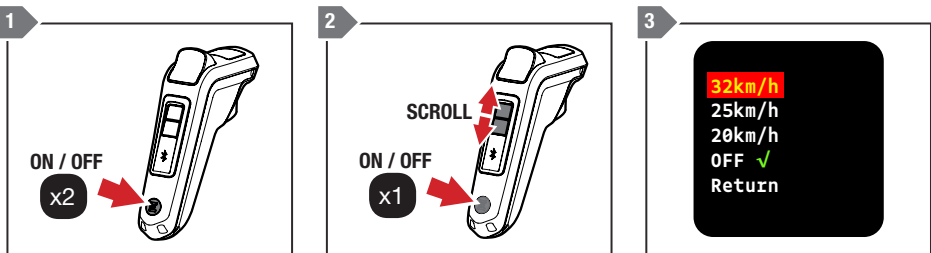



## R2 TRIGGER RESET PROCEDURE

If for some reason you are experiencing symptoms such as difficulty changing speed modes, unable to turn the remote off before the board and ability to brake but not accelerate, this is usually caused by knocks to the remote which then moves the triggers from its original position within the remote case.

In most cases this can be resolved by resetting the acceleration and brake trigger settings bringing it back to factory settings.

In the event the trigger settings are required to be reset, use the following steps:

1. Ensure the skateboard is turned off. Press the **ON/OFF BUTTON** on the remote.
2. From the default screen, double click the **ON/OFF BUTTON** to enter the remote menu.
3. Using the **MODE 2 BUTTON**, scroll down to highlight 'Product Info' and select by clicking the power button once.

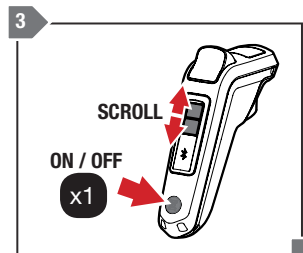
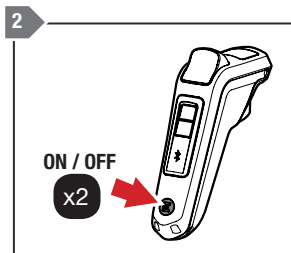
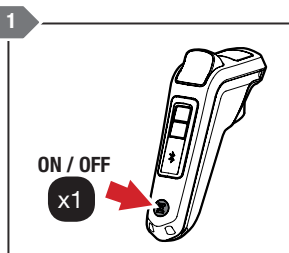

4. Perform the following sequence of button presses:

Double click  
**ON/OFF BUTTON.**

Double click  
**MODE 2.**

Double click  
**MODE 2** again.

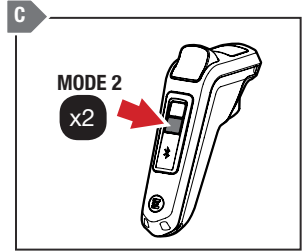
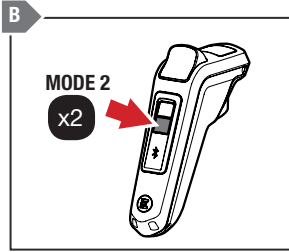
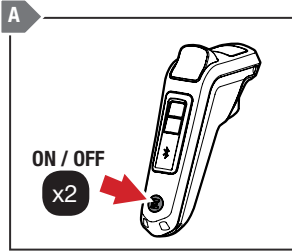

*The remote should now be in the trigger setting screen*

5. With 'Set ACC Min' highlighted, pull and hold the **ACCELERATOR TRIGGER** all the way in. Press the **ON/OFF BUTTON** once to set the value.

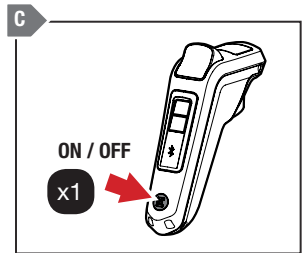
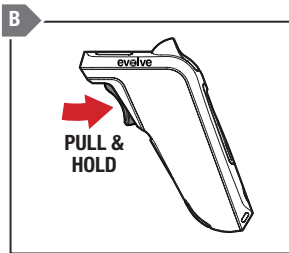
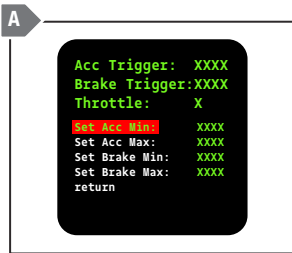

6. With 'Set ACC Max' highlighted, release the **ACCELERATOR TRIGGER** all the way and press the **ON/OFF BUTTON** once to set the value.

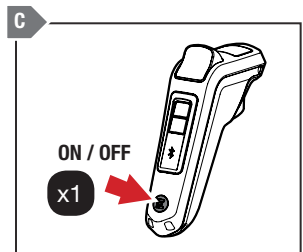
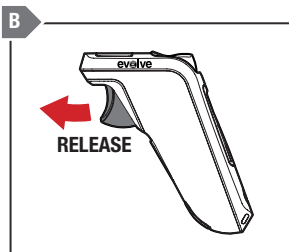
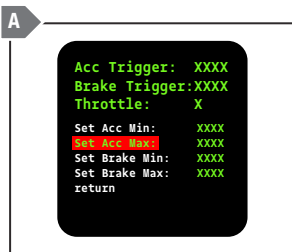

7. With 'Set Brake Min' highlighted, release the **BRAKE LEVER** entirely and press the **ON/OFF BUTTON** once to set the value.

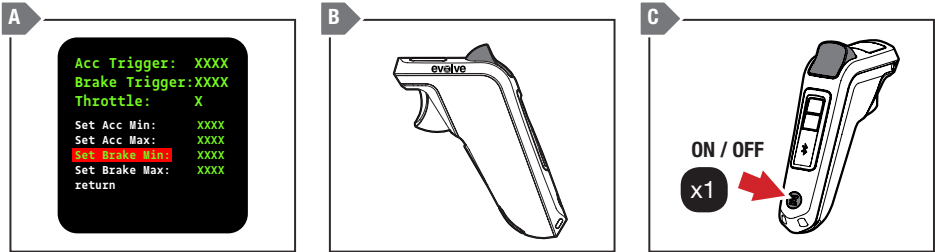

8. With 'Set Brake Max' highlighted, press and hold the **BRAKE LEVER** all the way in. Press the **ON/OFF BUTTON** once to set this value. Once the **ON/OFF BUTTON** is pressed the **BRAKE LEVER** can be released.

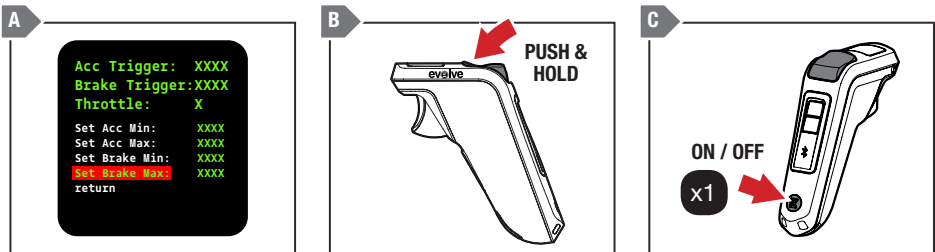

9. With 'return' highlighted, press the **ON/OFF BUTTON** once to exit the trigger screen. Turn the remote off by holding the power button for 1 – 2 seconds.

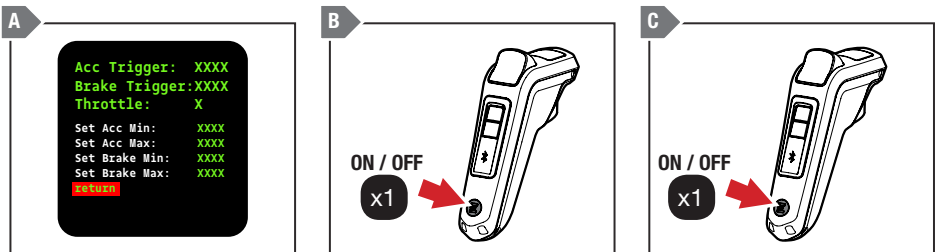

*The remote trigger limits have now been set.*



## OTHER REMOTE OPERATION FUNCTIONS AND TIPS

- If you accidentally press both the accelerator trigger and brake trigger at the same time, the brake function will work and cancel out the accelerator.
- If you hold down the accelerator and brake triggers then let the brake trigger go it will not accelerate.
- As you are riding and holding down the accelerator or brake trigger, you will not be able to change speed modes or turn the remote off until you let the triggers go.
- When the Safety Switch is enabled and you kick push the skateboard to start, you can avoid pressing in the Safety Switch, this is also good for battery efficiency.
- Get to know the vibration warnings on your remote, these can be useful during your ride.
- The LCD screen is much easier to see when there is less direct sunlight.
- The R2 remote will turn off after 5 minutes of non use to save on battery life.
- Avoid riding with your thumb positioned on the brake trigger as you are accelerating, this may cancel out the accelerator when you are not ready for it





## HEAT PROTECTION WARNING

To protect the entire electric system from over heating, we have created software that is designed to reduce the board performance. This forces it to cool down and prevent the rider continuing to put stress on the electric system.

If ever the system does reach this protection mode, the remote will automatically go to **PRO** speed mode and will vibrate one time and the km/hr reading will change to a red colour. During this time you will not be able to change speed modes above **PRO** speed until the board cools down to a safe temperature.

## **ERROR CODES**

If ever the board experiences an operational issue, an error message will be detected by the remote and displayed in the 'More Info' screen.

See below the list of Error Codes:

### **'BATT ERR'**

This error code may be displayed if there is an error in communication between the BMS and motor controller. In the event this occurs, the board will limit the speed mode to **SAFE MODE** to reduce the risk of damage to the battery.

### **'MAINTAIN BATT'**

This error code may be displayed if a cell in the battery is detected as being 'out of balance'. In the event this occurs, the board will limit the speed mode to **SAFE** to reduce the risk of damage to the battery.

### **'MOTOR # ERR'**

This error code may be displayed if an error has been detected from one, or both, of the motors in operation. The error will indicate 'Motor1 Err', 'Motor2 Err' or 'Motor1&2 Err'.

***IF EVER THE BOARD DOES EXPERIENCE AN OPERATIONAL ISSUE, PLEASE CONTACT YOUR LOCAL EVOLVE SKATEBOARDS SUPPORT TEAM FOR ASSISTANCE.***



## MAINTENANCE GUIDE

If you regularly clean and maintain your electric longboard, it will last a long time and ride at its best:

- Always clean your bearings for best roll and quietest/smoothest ride. Bearings get dirty and affect ride quality which may reduce battery performance and cause possible bearing failure.
- Always check all screws/nuts throughout the skateboard are tight (truck nuts, wheel nuts etc). You are responsible for this.
- Rotate the wheels on the skateboard as you would do so with any longboard skateboard, as the drive wheels will wear the fastest.
- Regularly clean & check the belt and drive gear for any damage. Replace if necessary.
- Always store your board at room temperature.
- Clean your board from dust and dirt so its looks and rides as new at all times. Use a damp & dry cloth to clean.
- Be sure to keep your All Terrain tyres between 30-45 PSI tyre pressure when riding. If the tyres run lower than this PSI then your ride times will reduce due to having flat tyres.

**NOTE -YOU ARE RESPONSIBLE FOR ALL MAINTENANCE RELATING TO THE EQUIPMENT, FAILURE OF ANY PART DUE TO LACK OF MAINTENANCE IS NOT COVERED BY WARRANTY.**



## BATTERY CARE

Your battery and therefore your board, should always be stored at room temperature. Excessive heat can permanently affect or damage the battery. The board does have heat protection software in place should this occur whilst riding to prevent the battery from overheating.

If left in a hot car, hot environment or exposed to other factors that may cause excessive heat, the heat protection software can't reduce temperatures, and your battery may be affected.

Cold temperatures will affect battery life and power output. If you are riding in low temperatures you may experience lower range, top speed and acceleration. Exposing the battery to excessively low temperatures may have a permanent effect or cause damage.

The battery cannot charge past 42 volts as the charger has voltage cutoff detection installed, however we recommend removing it from charge once the charger shows green.

If you will not be using your battery for a prolonged period of **3 MONTHS OR MORE**, it is recommended to **STORE IT BETWEEN 40 AND 50%**. Leaving it fully charged and unused can result in permanent loss of total capacity. If the battery is stored near depleted for a prolonged period it may drop to an unrecoverable voltage.



## TROUBLE SHOOTING

This manual is a quick start guide only. For detailed information regarding tips, maintenance and trouble-shooting, please visit **WWW.EVOLVESKATEBOARDS.COM**. Here you will find links to your local distributor for detailed information.

### WARRANTY

**THIS BOARD IS COVERED BY A 12 MONTH MANUFACTURERS WARRANTY (TIME PERIOD MAY BE DIFFERENT IN OTHER COUNTRIES SUCH AS USA AND EUROPE) THAT COVERS DEFECTS IN WORKMANSHIP AND MATERIAL. THIS DOES NOT COVER MISUSE, PERISHABLE ITEMS (SUCH AS WHEELS, TYRES, TUBES, BEARINGS, BELTS), NEGLIGENCE, ABUSE, ACCIDENT OR RIDING IN WATER AND SHIPPING DAMAGE.**

**FOR WARRANTY CLAIMS AND DETAILS, PLEASE VISIT YOUR LOCAL DISTRIBUTOR WEBSITE FOR INSTRUCTIONS. PLEASE KEEP YOUR SHIPPING BOX IN CASE THE BOARD EVER NEEDS TO BE RETURNED.**

Please contact your local distributor for **ALL** maintenance and trouble shooting questions.

You will also find many video tutorials on the distributor website.

**WWW.EVOLVESKATEBOARDS.COM**





**evolve**  
**SKATEBOARDS**  
[WWW.EVOLVESKATEBOARDS.COM](http://WWW.EVOLVESKATEBOARDS.COM)