

TENWAYS

AGO T

USER MANUAL



# FIND YOUR LANGUAGE

Scan the QR code to access the user manuals in  
German / Dutch / French / Italian / Spanish

User manuals in English / German / Dutch /  
French / Italian / Spanish are also available  
inside the **TENWAYS** App.



QR Code



# INDEX

## ASSEMBLE YOUR TENWAYS E-BIKE

---

Toolbox checklist	01
Bicycle structure and components	03
Assembly steps	07

## DISPLAY OPERATIONS

---

Display size	23
Buttons	24
Operation methods	25
User menu	30

## BIKE USAGE

---

Connect to the TENWAYS app	40
Before your first ride	40
Routine maintenance	43
Frame code	48

## IMPORTANT REMINDERS

---

Warranty	50
FAQ	51
Warnings	52

---

# TOOLBOX CHECKLIST

---

Tool Box

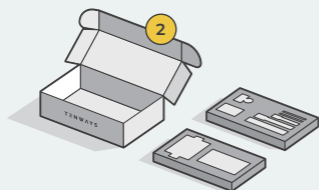

Battery Box

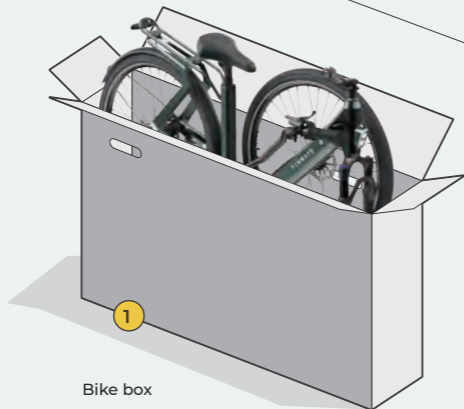
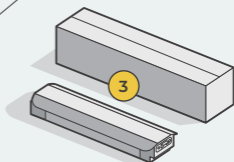

Bike box

# TOOLBOX CHECKLIST

---

## Tools

- No.3 Hex Key
- No.4 Hex Key
- No.5 Hex Key
- No.6 Hex Key
- No.10 Wrench
- No.15 Wrench
- Phillips Head Screwdriver

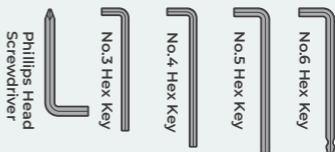

No.10 Wrench



No.15 Wrench

---

## Accessories

- Charger and adapter
- Bicycle Pedal L
- Bicycle Pedal R
- Portable Air Pump
- Front & Rear Reflectors

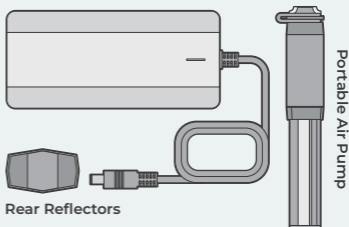

Rear Reflectors



Front Reflectors



Bicycle Pedals L

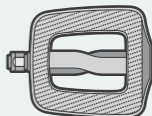

Bicycle Pedals R

# BICYCLE STRUCTURE AND COMPONENTS

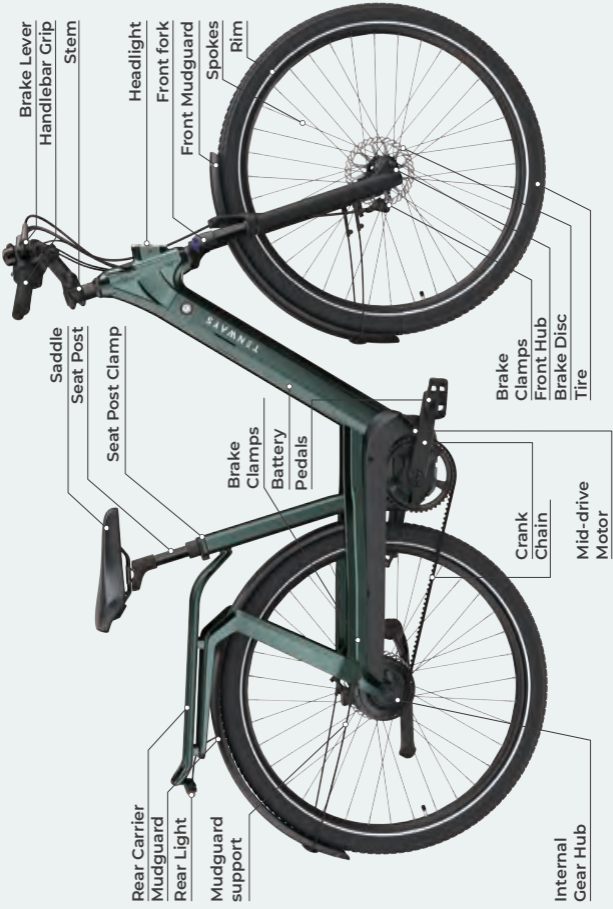

# BICYCLE STRUCTURE AND COMPONENTS

---



# ASSEMBLE YOUR TENWAYS E-BIKE

01.

INSTALL THE HANDLEBAR

02.

DETACH THE FRONT WHEEL

03.

INSTALL THE KICKSTAND



04.

**PRE-INSTALL THE QUICK RELEASE**

05.

**INSTALL THE FRONT WHEEL**

06.

**INSTALL THE FRONT MUDGUARD**

07.

**INSTALL THE BATTERY**

08.

**INSTALL THE PEDALS**

09.

**ADJUST THE HEIGHT OF THE SADDLE**

10.

**INSTALL THE REFLECTORS**

# 01.

## INSTALL THE HANDLEBAR

---

**Tools needed: No.4 Hex Key**

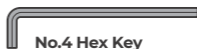

**01**

Hold down the front fork with one hand and turn the stem to the front, then remove its front attachment with **No.4 Hex Key**.



# 01.

## INSTALL THE HANDLEBAR

---

**Tools needed: No.4 Hex Key**

**02**

Put the handlebar into the stem handlebar slot, then align their centers. Use the **No.4 Hex Key** to tighten the screws in diagonal order (with 5–6 Nm torque).

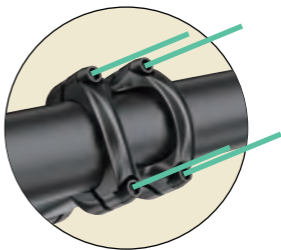

# 01.

## INSTALL THE HANDLEBAR

---

**Tools needed: No.5 Hex Key and No.6 Hex Key**



### 03

Adjust the direction of the headset, and use the **No.5 Hex Key** to tighten the screws at the stem and front fork (with 5-6 Nm torque).

### 04

The height of the handlebar can be adjusted by with the **No.6 Hex Key**. Please remember to tighten back the bolt after adjustment (with 20-25 Nm torque).

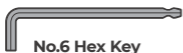

No.6 Hex Key



# 02.

## DETACH THE FRONT WHEEL

---

Remove the front wheel and the plastic protective covers on both sides of the wheel.



**Attention:** You must remove the front wheel in the direction of the spokes to avoid scratching them.

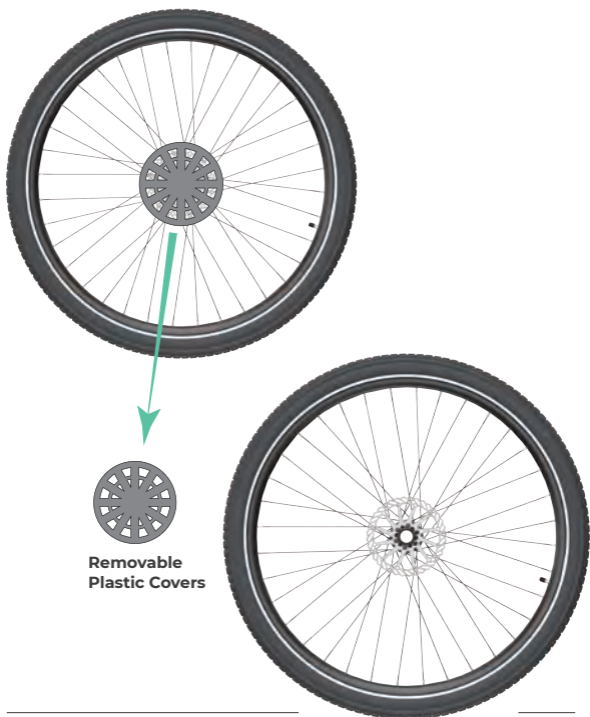

# 03.

## INSTALL THE KICKSTAND

---

### Tools needed:

**No.4 and No.5 Hex Keys**

#### 01

Use the **No.5 Hex Key** to fix the kickstand on the frame (torque: 9 -12 Nm)

#### 02

Use the **No.4 Hex Key** to adjust the kickstand length - we recommend adjusting the length to the longest setting (torque: 5 - 7 Nm)

#### 03

Position your e-bike with the kickstand to facilitate the next installation steps.

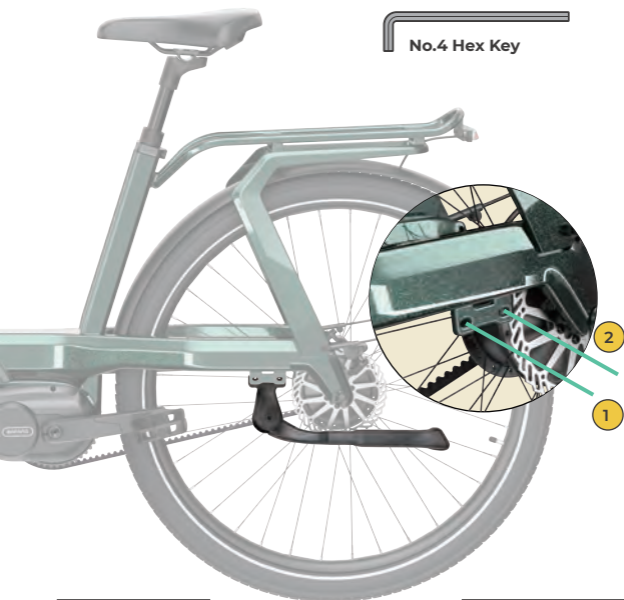

# 04.

## PRE-INSTALL THE QUICK RELEASE

---

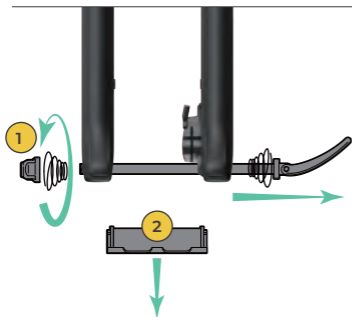

**01**  
Loosen the nut and remove the quick release lever.

**02**  
Remove all wrapping material from the quick release.

**03**  
Install the quick release on the front wheel in the direction shown in the figure, and then tighten the nut.



**Note:** There is no need for you to fully tighten the nut at this time.



**Note:** When installing the quick release spring, ensure that the direction is the same as when it was removed.

05.

## INSTALL THE FRONT WHEEL

---

**01**

Set the quick release lever to the open position and remove the protective sheets from the brake clamps. Guide the front fork to the front wheel.

Make sure that the front wheel is centered, and the brake disc is in the middle of the brake clamps.

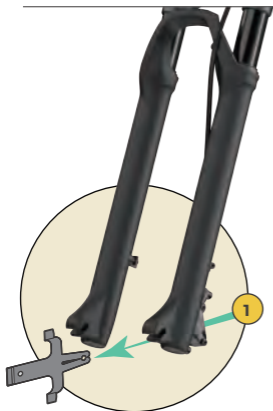



05.

## INSTALL THE FRONT WHEEL

---



### 02

Tighten the quick release nut, and then turn the quick release lever to the closed position as shown in the figure.



### 03

Push the bike back and forth and press the brake to check if the front wheel wobbles. If so, please repeat step 2 until you feel enough resistance when closing the quick release lever.

### 04

Turn the front wheel by hand and check if there are any signs of scraping.

# 05.

## INSTALL THE FRONT WHEEL

---

### 05

If scraping occurs, follow the steps below to make adjustments:

- Use the **No.5 Hex Key** to slightly loosen the mounting screws of the brake clamps so that they can move slightly.
- Press the front brake 3 to 5 times.
- Hold the front brake lever and tighten the mounting screws of the brake clamps.



**No.5 Hex Key**



## 05.

### BAUEN SIE DAS VORDERRAD EIN

---

- Turn the front wheel by hand and check for the sound of friction.
- If you hear friction, loosen the mounting screws of the brake clamps.



**Note:** This step is very important. Please follow the instructions carefully. (Keep the protective sheets from the brakes for future use.)

## 06.

### INSTALL THE FRONT MUDGUARD

---

**Tools needed: No.4 and No.5 Hex Keys**

#### 01

Adjust the distance between the mudguard and the tire, then use the **No.5 Hex Key** to fix the mudguard lug to the front fork. The torque should be 8-10 Nm.



**No.5 Hex Key**

06.

## INSTALL THE FRONT MUDGUARD

---



**Tools needed: No.4 and No.5 Hex Keys**

**02**

Use the **No.4 Hex Key** to fix the mudguard supports. The torque should be 3-4 Nm.

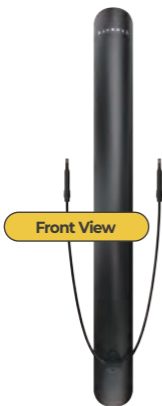

# 07.

## INSTALL THE BATTERY

---

**01**

Tilt and slide the lower end of the battery into the battery slot, and then press the upper end upwards by hand.

**02**

You will hear a click when the battery is firmly seated.

Battery Pack Front

Battery Pack Right



# 08.

## INSTALL THE PEDALS

---

**Tools needed: 15mm Wrench**

**01**

Distinguish between the left and right pedals. The right and left pedals are marked by an L and an R respectively. The right pedal is used for the side with the crankset, while the left one is used for the other side.

**02**

Tighten the right pedal clockwise and the left pedal counterclockwise.

**03**

Stop tightening the pedals if you feel a lot of resistance. If this happens, realign and re-install the pedals.



15mm Wrench



**Note:** Do not install the pedals forcibly if you feel great resistance.

# 09.

## ADJUST THE HEIGHT OF THE SADDLE

---

**Tools needed: No.5 Hex Key**

Loosen the clamp screw, adjust the saddle cushion to a suitable height, and then tighten the screw.

**Note:**

The height of the seat post should not exceed the marked safety line. The minimum height to which the seat post can be set is determined by the maximum amount by which the post can be inserted into the frame.



# 10.

## INSTALL THE REFLECTORS

---

### Tools needed:

**Phillips Head Screwdriver.**

#### 01

Distinguish between the front reflector and the rear one. The rear reflector is red, while the front one is white.

#### 02

Use the Phillips Head Screwdriver to install the rear reflector to the seat post and the front one to the handlebar.





# DISPLAY OPERATIONS

01.  
DISPLAY SIZE

02.  
BUTTONS

03.  
OPERATION METHODS

04.  
USER MENU

# 01.

## DISPLAY SIZE

---

**Front view**

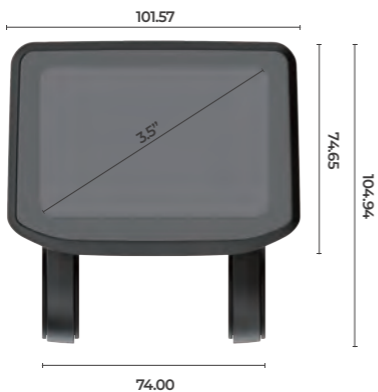

**Side view**



**Top view**



## 02.

### BUTTONS

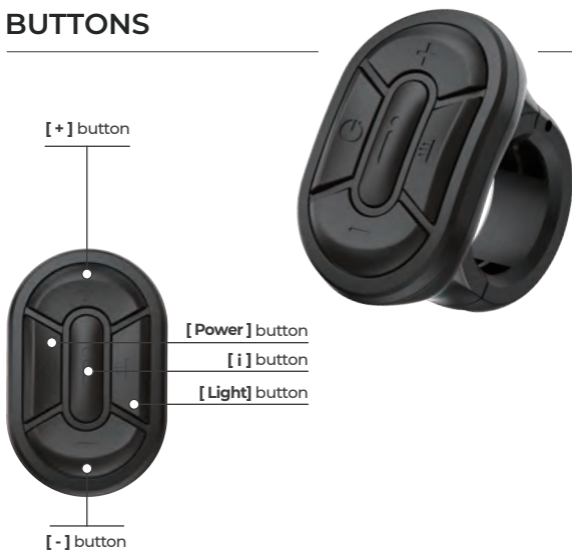

Button	Name	Functions
⏻	[ Power ] button	1. Turn the display on/off.
+	[ + ] button	1. Adjust parameters. 2. Menu operations.
-	[ - ] button	1. Adjust parameters. 2. Enable/disable the assistance function. 3. Menu operations.
☛	[ Light ] button	1. Turn the headlight on/off.
i	[ i ] button	1. Switch the information bar. 2. Confirm the function. 3. Menu operations.

# 03.

## OPERATION METHODS

---

### 3.1 Turn the display on/off

---

Press and hold the **[Power]** button to access the logo interface after 2s and the password interface after another 2s (the default password is 0000). You can access the riding data interface after you enter the correct password. Press and hold the **[Power]** button to turn off the display.

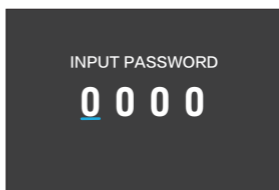

**Note:** Please only take the display operations mentioned in this manual as a reference, as the actual interface may be slightly different if the software gets updated later. If you have any questions, please email [support@tenways.com](mailto:support@tenways.com).

# 03.

## OPERATION METHODS

---

### 3.2 Riding interface

---

Various riding parameters are shown in the main interface below. Ranges can be displayed on this interface. These are listed in table 1.



# 03.

## OPERATION METHODS

---

### 3.2 Riding interface

---

Table 1 parameter ranges

Information Area	Display	Range	Unit
ODO	Total Distance	Calculation range: 0.0 - (32 digits) Display range: 0 - 999999 km/ miles	km or mile
Trip	Trip Distance	Calculation range: 0.0 - 99999.9 Display range: 0.0 - 99999.9 km/miles	km or mile
The trip time	Trip Time	9999:59	HH:MM
Average speed	Avg. Speed	0.0 - 99.9	km/h or mph
Maximum speed	Max. Speed	0.0 - 99.9	km/h or mph
Remaining distance	Range	0 - 999	km or mile
Carbon emission saved	CO <sub>2</sub>	0 - 999999	kg
Trees saved	Trees Saved	0 - 999999	trees

# 03.

## OPERATION METHODS

---

### 3.3 Changing the PAS levels

---

Click the [ + ] or [ - ] button to shift gears.

Press and hold the [ - ] button for 1s to enter the 6 km/h assistance mode, and release this button to exit the mode.

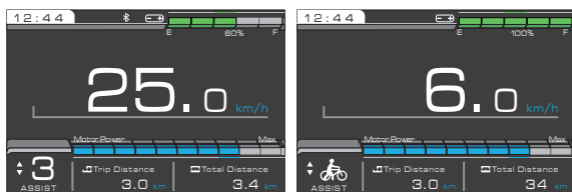

### 3.4 Turn the lights ON / OFF

---

Press and hold the [ + ] button for 1s to turn the lights **ON / OFF**.

# 03.

## OPERATION METHODS

---

### 3.5 Endurance distance

---

The endurance distance range is 0 to 999 km or mile.  
A "--" will be displayed if the value is not calculated.

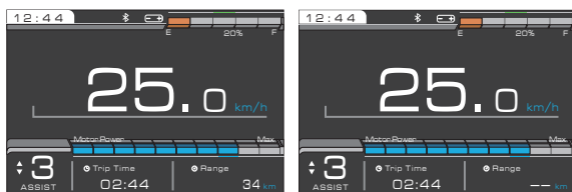

### 3.6 Error codes

---

Common error codes (the following information is only for reference. If you see an error code, please contact **TENWAYS** customer service at [support@tenways.com](mailto:support@tenways.com).)

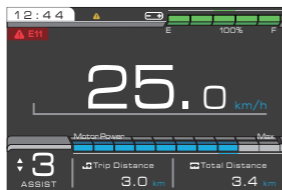



# 04.

## USER MENU

---

When the e-bike is stationary and not displaying any errors, press and hold the [ **i** ] button on the main interface for 2s to enter the user menu interface. You can check or update the trip information, unit, backlight brightness, auto power-off time, speed limit, user password, system information, date and time, and Bluetooth connection on this interface.

The system returns to the riding interface automatically if no operation is performed on the interface for more than 60s.

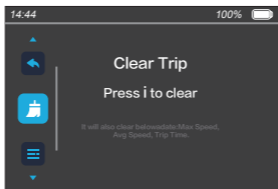

# 04.

## USER MENU

---

### 4.1 Clear the trip mileage

After entering the menu preview interface, press the [ i ] button to enter this menu item. Click the [ + ] or [ - ] button to select Yes or No (default), and then click the [ i ] button to confirm and save the setting, and switch to the next menu interface. Both Trip and Trip Time will be reset if you return.

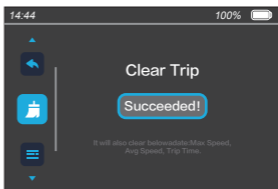
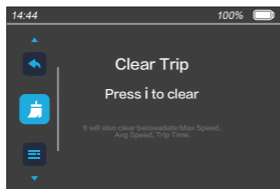

**Note:** The maximum speed, average speed, and total trip time will also be reset when the trip mileage is reset.

# 04.

## USER MENU

---

### 4.2 Unit settings

---

After entering the menu preview interface, press the **[i]** button to enter this menu item, and then click the **[+]** or **[-]** button to switch between km/h and mph. Press the **[i]** button to confirm and save the setting, and switch to the next menu preview interface.

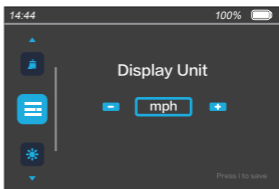
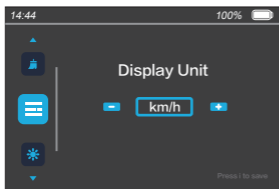

# 04.

## USER MENU

---

### 4.3 Backlight brightness settings

---

After entering the menu preview interface, press the [ i ] button to enter this menu item, and then click the [ + ] or [ - ] button to set the brightness to AUTO, 1, 2, 3, 4, or 5. AUTO means automatic backlight.

Click the [ i ] button to confirm and save the setting, and switch to the next menu preview interface.

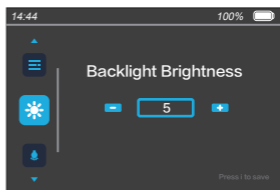
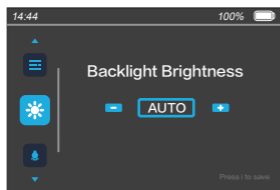

# 04.

## USER MENU

---

### 4.4 Set the auto power-off time

---

After entering the menu preview interface, press the [ i ] button to enter this menu item, and then click the [ + ] or [ - ] button to set the auto power-off time to a value ranging from 1 minute to 99 minutes. OFF means the auto power-off function is disabled.

Click the [ i ] button to confirm and save the setting, and switch to the next menu preview interface.

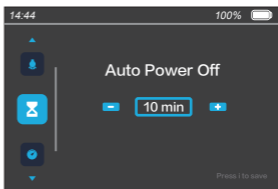
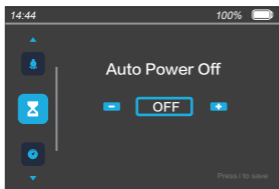

# 04.

## USER MENU

---

### 4.5 Auto headlight settings

---

After entering the menu preview interface, press the [ i ] button to enter this menu item, and then click the [ + ] or [ - ] button to select from **ON / OFF**.

Click the [ i ] button to confirm and save the setting, and switch to the next menu preview interface.

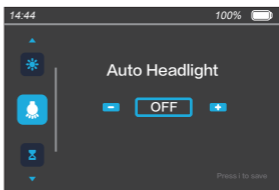
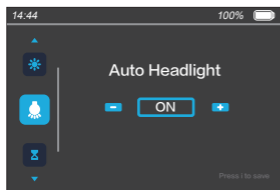

# 04.

## USER MENU

---

### 4.6 User password settings

---

After entering the menu preview interface, press the [ i ] button to enter this menu item. Click the [ + ] or [ - ] button to select the Password option, and press the [ i ] button to enter the Password item and select **ON** or **OFF**. Click the [ i ] button to confirm the adjustment and exit.

When the Password option is **ON**, press the Power button to confirm and enter the Change Password item and change the current password by starting from the first digit. Click the [ + ]

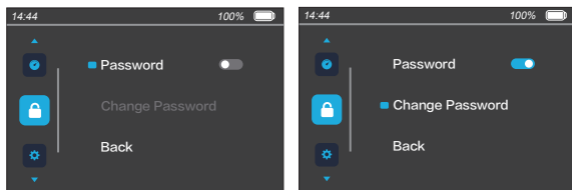

# 04.

## USER MENU

---

or [i] button to select a number from 0 to 9, press the Power button to confirm the setting and go to the second digit. Repeat the operation to set the entire password.

Select Back to exit the user password setting interface.

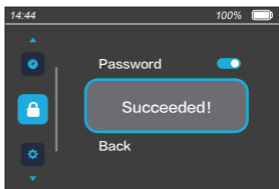
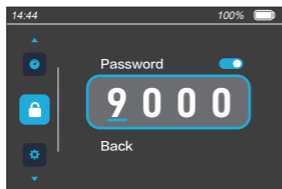

### 4.7 System information

---

System information such as the software version will be displayed after you enter the menu preview interface. The version shown in the figure below is just an example.

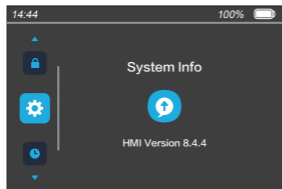



# 04.

## USER MENU

---

### 4.8 Time and date settings

---

After entering the menu preview interface, press the [ i ] button to enter the date and time settings. Click the [ + ] or [ - ] button to select a value ranging from 2000 to 2099 after the year flashes. Click the Power button to confirm the setting. Next, go to the month item and select a value ranging from 01 to 12. Click the Power button to confirm the setting. Next, go to the day item and select a value according to the calendar. Click the Power button to confirm the setting. Next, go to the hour item and select a value ranging from 00 to 23. Click the Power button to confirm the setting. Finally, go to the minute item and select a value ranging from 00 to 59.

Click the [ i ] button to confirm and save the setting, and switch to the next menu preview interface.

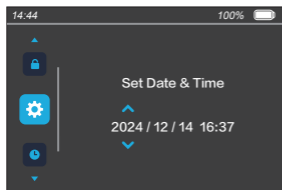

# BIKE USAGE

01.  
CONNECT TO THE TENWAYS APP

02.  
BEFORE YOUR FIRST RIDE

03.  
ROUTINE MAINTENANCE

04.  
FRAME CODE

# 01.

## CONNECT TO THE TENWAYS APP

---

1. Turn on the Bluetooth feature on your phone.
2. Open the **TENWAYS** app..
3. Tap "**Register**", and then scan the QR code on the frame. The QR code can be found near the bottom bracket at the bottom of the frame down tube.
4. Fill in the colour and saddle height of your e-bike, and give your e-bike a name.
5. Turn on the display of your e-bike, and enter the password.
6. Select the name of the Bluetooth beginning with AGO T and click for connection. From now on, your TENWAYS account will be bound to the connected e-bike. The next time you use the app, it will automatically connect to the e-bike within 10 seconds.

# 02.

## BEFORE YOUR FIRST RIDE

---

- Charge the battery to 100% before your first ride.
- When charging your e-bike:
  - Charge the bike indoors and keep it away from direct sunlight, rain, or snow.
  - Use only the **TENWAYS** charger to charge the bike.
  - Ensure a proper ambient temperature. The best ambient temperature for the charger is between 20°C and 25°C. A

# 02.

## BEFORE YOUR FIRST RIDE

---

lower temperature may lead to insufficient charging, while a higher temperature may lead to overcharging.

- It is recommended to remove the charger immediately after the bike is fully charged to avoid overcharging the battery.
- When using the charger to charge the battery, connect the charger to the battery charging port, and then connect the charger to the power socket. When removing the charger, disconnect the charger from the power socket, and then disconnect the charger from the battery charging port.
- Check the tire pressure by hand or with a gauge and ensure the pressure is within the range of 50- 75 PSI or 3.4 - 5.1 bar.
- Test the belt drive to check whether the belt tension is suitable (you should be able to press the middle part of the belt down 10 - 15 mm if the tension is moderate).
- Before riding your e-bike on roads, ensure compliance with local riding regulations, for example those governing riding equipment, control lights, and reflectors. Asegúrate de que llevas el equipo de protección adecuado.
- Make sure that you wear the correct protective equipment.
- Always wear a helmet and ensure that your vision is clear.
- When properly adjusted, the saddle should be at hip height.
- Check and ensure that the front wheel quick release,

## 02.

### BEFORE YOUR FIRST RIDE

---

- handlebar, brakes, pedals, and other related parts of the e-bike are properly fastened before you start to ride.
- The brake settings vary by country / region. Check which brake lever acts on which brake first, and if it does not comply with your habits, we recommend that you ask an expert to change the settings so that you can accurately brake the front and rear wheels if an emergency occurs while you're riding. If you encounter any problems while riding, brake first ( brake both wheels at the same time to stop within the shortest possible distance ).
- Check the steering. The steering has a crucial impact on braking and riding safety.
- We recommend that you purchase relevant insurance for bikes or e-bike riding in your area. This way you can contact your insurance company or agency promptly to get adequate protection in the event of an accident.

# 03.

## ROUTINE MAINTENANCE

---

### Daily inspection

- Before riding, check that screws in the following key parts are properly tightened:
  1. Screws between the stem and the front fork stem
  2. Screws between the stem and the handlebar
  3. Screws between the brake lever and the handlebar
  4. Screws between the brake clamps and frame or front fork
  5. Screws between the discs and bottom brackets
- Use the tools provided to tighten any loose screws.
- After all screws are properly tightened before the first ride, check that they have maintained the same fastening performance after 200 km of riding. Following the initial 200km, check the screws after every 1000 km of riding.
- It is recommended to check the fastening performance of screws after every 600 km if you usually ride under complex road conditions.

# 03.

## ROUTINE MAINTENANCE

---

### Daily cleaning

- Use a rag or large brush to clean off dust when there is not much mud on your e-bike.
- When there is a lot of mud on your e-bike, use a brush dipped into soapy water to wash it off, rinse it with a little clean water, then dry it with a soft cloth.
- Check the wear degree of the brake blocks after you have cleaned them to see if they can ensure normal braking. Replace them promptly if they are seriously worn.
- It is recommended to clean the e-bike after you ride it for about 200 km. You need to clean the bike first before you put it into storage if you plan to not ride for a long period of time.



**Note:** Do not clean the bike with a high-pressure water gun, as this might damage the mechanical pivots and related mechanical fitting parts.

# 03.

## ROUTINE MAINTENANCE

---

### How to maintain the battery

Operating and storage temperatures of the battery:

- The working temperature of the lithium battery is 0°C to 30°C.
- It is recommended that the lithium battery be stored in an environment where the temperature is 0°C to 25°C with 65±20% RH.
- The performance of lithium batteries is affected by the ambient temperature. Don't worry if the performance of your battery degrades in cold weather. The battery performance will resume when the temperature rises.
- If possible, the battery should not be charged above 95% or discharged below 10%, as this may decrease battery life. A reasonable charging and discharging scheme can mitigate accelerated battery deterioration or damage.
- If you are not using your e-bike for an extended time, keep the power at 50% to 70%, check the battery condition every 2 months to avoid damage caused by over-discharging, charge and discharge the battery every 3 months.



# 03.

## ROUTINE MAINTENANCE

---

### How to maintain the brakes

- The new brake blocks and discs feature relatively smooth surfaces, so the braking effect will improve after you ride 100 km or brake on long downhill 3 to 5 times, when such surfaces become roughened.
- Check screws between the brake lever and the handlebar, as well as screws between the brake clamps and frame or front fork:
  1. Check if these screws maintain the same fastening performance when your e-bike reaches a 200 km riding distance.
  2. Check the fastening performance at every 1,000 km after the initial 200 km.
  3. It is recommended to check the fastening performance of screws after every 600 km if you often ride under complex road conditions.
- The wear degree of brake blocks should be checked after you've ridden on normal roads for 1,000 km, or 600 km if the road conditions are complex. The blocks should be

# 03.

## ROUTINE MAINTENANCE

---

replaced promptly when they are two-thirds or more worn.

- If you feel that the brakes are obviously loose but the wear degree of brake blocks is still acceptable and there is no sign of oil leakage on the brakes, contact a professional bike store and ask technicians to replenish the lubricant.
- Contact a professional bike store and ask technicians to diagnose and fix the cause of any abnormal noise that persists during riding after you have cleaned any oil from the brake blocks and discs.

### **Professional store maintenance**

It is recommended to go to a professional bike store for maintenance 2-3 times a quarter, or after every 1,000 km of riding. The following items should be checked / performed during such maintenance:

- Performance of the hydraulic brakes.
- The fastening performance of screws in key parts, especially those between.
- The wear degree of the front fork parts.
- The wear degree of the front hub bearings.

## 03.

### ROUTINE MAINTENANCE

---

- The wear degree of the pedal pivots.
- The professional store should lubricate the internal pivots to ensure the smoothness of pivots in front fork parts, front hub bearings, bottom bracket, and other parts.
- The wear degree of the tires.
- The fastening condition of sensors, the battery, controller, motor, odometer, and other electronic control parts.

## 04.

### FRAME CODE

---

The frame code, which is in the form of a QR code, can be found near the bottom bracket at the bottom of the frame down tube.

You can scan the QR code with your phone to see the 18-digit frame code. You can use the frame code to purchase insurance.

Please provide your frame code information when contacting us for consultation.

# IMPORTANT REMINDERS

01.  
WARRANTY

02.  
FAQ

03.  
WARNINGS

# 01.

## WARRANTY

---

- This product has passed the relevant certification of EN15194-2017 electrically powered assisted cycles regulations.
- All original components are covered by warranty for a period of two years from the date of delivery.
- Claims within the warranty must be made directly to **TENWAYS** and a proof of purchase is required.
- The warranty applies to original owners and is transferable to further owners.
- The warranty does not cover the following circumstances:
  1. An incorrect assembly or installation of the product by the user.
  2. An improper or negligent use, operation or transformation of the product.
  3. A maintenance contrary to the maintenance instructions of the product ( e.g., lack of maintenance of the brakes).
  4. Normal wear and tear.
  5. Defects inherent to the normal useful life or service life of the product.
  6. Damages or defects due to accidents.

# 02.

## FAQ

**Q:** What type of e-bike is this e-bike? Which terrains is this e-bike targeted at?

**A:** This is the AGO T e-bike. It's an urban commuter intended for urban pavement or slightly potholed roads. Do not ride it on mountain roads, otherwise accidents may occur.

**Q:** What is the weight of the whole bike including the battery?

**A:** It's approximately 30.5 kg.

**P:** What should I do if any parts are damaged or any abnormality occurs during use?

**A:** Please contact **TENWAYS** customer service immediately, or turn to bike-repair professionals for inspection and maintenance.

**Q:** How long would it take to fully charge the battery?

**R:** Approximately six hours.

**Q:** What is the riding distance of one battery charge?

**A:** 65 to 100 km.

**Q:** What are the tire pressure requirements?

**A:** Air pressure of the tires should be within the range of 40-65 PSI or 2.8-4.5 bar.

**Q:** What is the proper belt tension?

**A:** The tension value should stay within 45 to 60 Hz (35 to 45 lbs). The means the middle part of the belt should sink approximately 10 to 15 mm when you press it down by hand.

**Q:** What is the overall noise level of this product while riding?

**A:** This product has passed the relevant certification of EN15194-2017, meaning the rider will not hear any sound higher than 70 dB from this e-bike during riding.

# 03.

## WARNINGS

---

- This bike is designed for urban riding only. Do not use it for racing, mountain biking, or other non-urban usage scenarios. It is important to understand your e-bike and its intended use, as personal safety incidents may occur when you use it in wrong usage scenarios.
- Inspection and maintenance is very important to the safety and service life of your e-bike. You should check the brakes, tires, handlebar, and rims regularly. Any unmaintained parts may break or perform poorly, possibly causing life-threatening accidents.
- If you choose to attach a spring-loaded child seat, please make sure it is installed and fitted correctly to avoid possible injury.
- Your bike must comply with legal regulations for riding on public roads in all conditions, including inclement weather, at night, early morning or dusk. It is your responsibility to familiarize yourself with and comply with all applicable laws in your country, including properly equipping you and your bikes as required by law.
- Improper fitting, installation, operation and maintenance of any accessories and parts may cause serious personal injuries or even death. Do not modify the frame or original components in any way. Modifications may cause damage to your e-bike and lead to life-threatening accidents. Mismatched accessories or incorrect installation can affect

# 03.

## WARNINGS

---

- product performance and make riding unsafe.
- Like all mechanical parts, bikes are also subject to wear and stress. Different materials and components may react to wear or stress fatigue in different ways. Make sure you have spare parts ready for tires, brake blocks, and other wear-and-tear parts. If the design life of a component has been exceeded, it may suddenly fail, causing injuries to the rider. Any cracks, scratches or color changes indicate that the life of the component has been reached and it should be replaced.
- Extra caution should be exercised when you install any third-party accessories on your bike. Child seats and racks may increase the load and raise the overall center of gravity for the bike. If the bike gets out of control, you and the child passenger may be injured or even killed.
- Do not touch the brake discs while the front and rear wheels are still turning, or after you use the brakes. You may be injured or burned.
- If you have any questions related to the battery, contact **TENWAYS'** customer support team.
- A great deal of concentration is required when you're riding. Sudden braking or steering may result in an accident.
- Do not modify or tamper with the motor and built-in computer



# 03.

## WARNINGS

---

- system of the bike. Modification or tampering of any kind will void your warranty and may cause a life-threatening accident.
- The brake settings vary by country/region. Check which brake lever acts on which brake first. If it does not comply with your habits, we recommend that you ask an expert to change the settings.
- Urban cycling can be dangerous. Riding without a helmet can result in serious injuries or even death.
- Do not use a headset or talk on the phone while riding.
- Do not ride when you don't have full control of the bike.
- Ride with extra caution on slippery surfaces or under humid weather. Ride slowly and brake lightly to allow for longer braking distances.
- Your riding speed should fit the road conditions, your capabilities, and local laws and regulations.
- Featuring better braking ability, our disc brakes may perform differently from other brake systems. Please familiarize yourself with their performance before you ride for the first time.
- Ensure that all lights function properly and are not blocked. We recommend the use of lights in all environments to ensure maximum visibility.
- Do not keep the motor running under high load for a long

# 03.

## WARNINGS

---

- time.
- Do not charge the bike with any non-**TENWAYS** chargers.
- Do not place the bike in or near a strong magnetic field, or put any magnetic objects near the bottom bracket.
- The bike is designed to withstand a maximum weight of 120 kg. Exceeding this weight may cause a life-threatening accident.
- Do not hang bags, umbrellas, and other overly large or heavy items on the handlebar.
- Do not wear overly long clothes while riding, as they may get entangled in the wheels or crankset.
- Do not attempt to open or touch the internal components of the e-bike, as this may cause permanent damage.
- Do not strike or damage the motor or its casing, or immerse the motor in water.
- Unless required for maintenance, do not attempt to remove the display.
- Do not use the components of other e-bike brands on **TENWAYS** e-bikes.
- This manual cannot cover the installation and maintenance methods for each e-bike part. The technical details shown in texts and illustrations in the manual may also



## ATTENTION

- The battery pack **MUST** be locked onto the frame battery mount before use.
- Ensure the battery and charger are not damaged before charging.
- Don't connect the positive and negative terminal of the battery pack.
- Don't expose the battery to high temperatures.
- Ensure the battery charger is unplugged from the battery pack and put away before you ride.
- Always charge your battery in temperatures between 10 and 26 degrees Celsius.
- Do not subject the battery to salt water or leave the bike for extended periods in the rain.

RoHS



Lithium